

MODEL 20405x50A

REPAIR PARTS

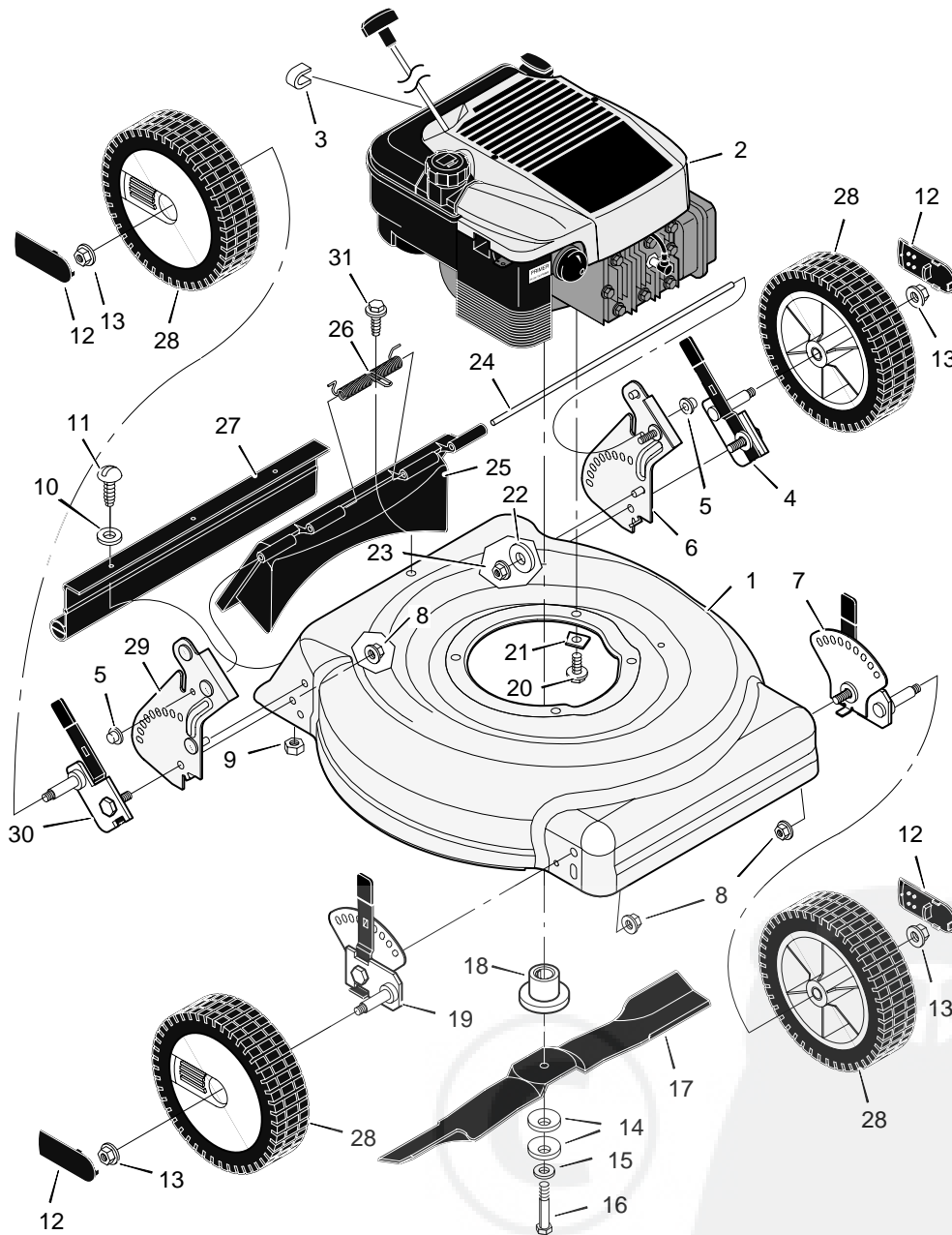

1	Housing	776005	12	Hub Cap - Optional	672122	23	Nut, Flange	15x79
2	Engine *	*	13	Nut, Flange	15x84	24	Rod, Pivot	215x17 Z
3	Stop, Rope (Recoil-Start)	42189	14	Washer, Belleville	17x137	25	Door, Rear	672107
4	Adjuster, Left Height	671975	15	Washer	17x124	26	Spring	166x44
5	Push On Cap	28x42	16	Bolt	17x142	27	Guard, Rear	671990
6	Bracket, Left Handle	671943	17	Blade	671921E701	28	Wheel	71132
7	Adjuster, Left Front Height	671973	18	Adapter, Blade	71056	29	Bracket, Right Handle	671944
8	Nut, Flange	15x68	19	Adjuster, Right Front Height	671972	30	Adjuster, Right Height	671974
9	Nut, Hex	15x102	20	Bolt, Engine	25x6	31	Screw	26x259
10	Washer	17x38	21	Support, Engine	671989	--	Instruction Book	F-97447
11	Screw	4x21	22	Washer	17x146			

MODEL 20405x50A

REPAIR PARTS

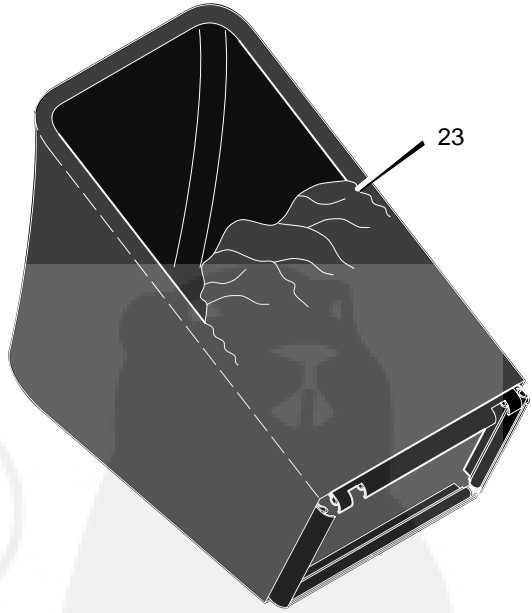
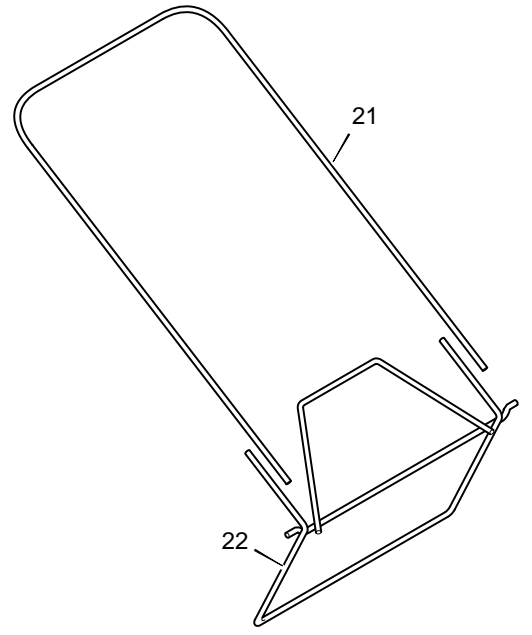
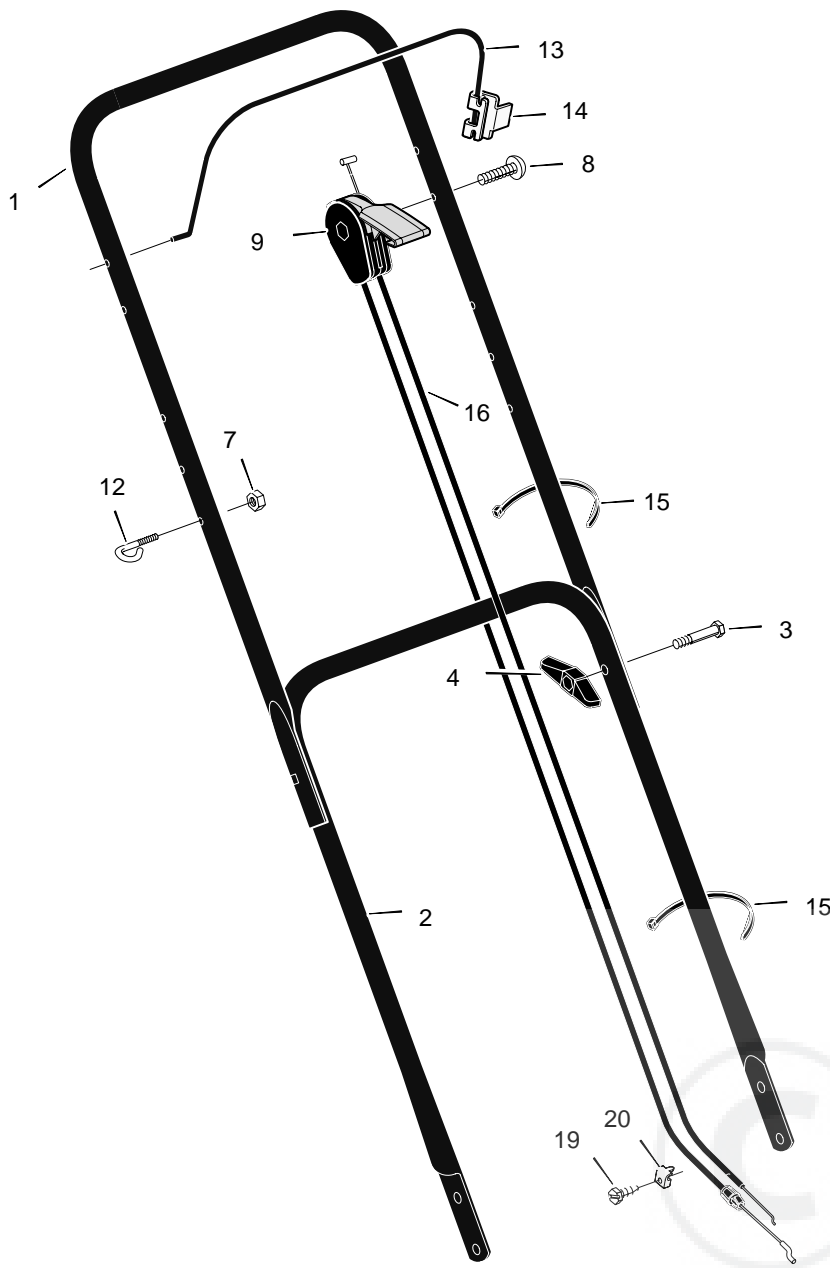

1	Handle, Upper (Gray)	671918E724	9	Throttle Control	672142	19	Screw	26x268
2	Handle, Lower (Gray)	671917E724	12	Guide, Rope	43956	20	Clamp	42294
3	Bolt	2x77	13	Engine Stop Lever	671924E700	21	Frame, Top	71592
4	Knob, Plastic	71294	14	Bracket, Stop Lever	43628 BC	22	Frame Assembly	672068
7	Locknut	15x116	15	Fastener, Cable	71372	23	Bag, Cloth	672110
8	Screw	3x144	16	Engine Stop Cable	672127			